

CONJUNTO SEMICARTER

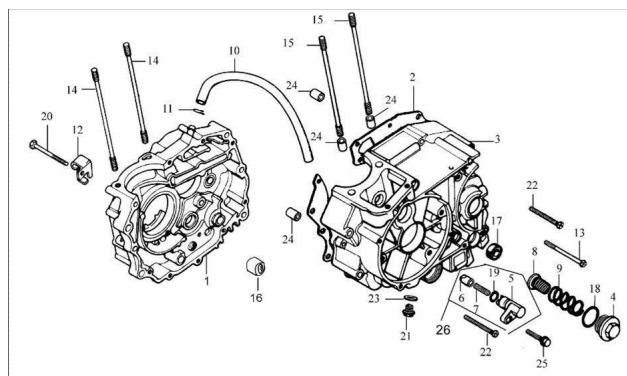

Rating: Not Rated Yet

Price:

Variant price modifier:

Base price with tax:

Price with discount:

Salesprice with discount:

Sales price:

Sales price without tax:

Discount:

Tax amount:

[Ask a question about this product](#)

| Description | Ref. | Título | Código |
|-------------|------|-------------------------------------|----------|
| | 1 | SEMICART ER LADO EMBRAGUE | 28-11110 |
| | 2 | JUNTA CENTRAL S EMICARTE R | 28-11119 |
| | 3 | SEMICART ER LADO VOLANTE | 28-11210 |
| | 4 | TAPON FILTRO DE ACEITE | 28-15463 |
| | 5 | CLAVIJA SUJETA PALANCA | 28-11231 |

MOTOR : CONJUNTO SEMICARTER

| Ref. | Título | Código | |
|------|--------|--|--------------------|
| | 6 | BUJE | 28-11232 |
| | 7 | RESORTE CLAVIJA SUJETA PALANCA | 28-11233 |
| | 8 | ELEMENTO FILTRANTE | 28-15450 |
| | 9 | RESORTE SUJETA FILTRO DE ACEITE | 28-15461 |
| | 10 | MANGUER A RESPIRA CION CARTER | 28-20152 |
| | 11 | ABRAZADE RA | 28-20153 |
| | 12 | FIJACION CABLE DE EMBRAGUE | 28-22824 |
| | 13 | TORNILLO M6 X 95 | 28-GB/T166 74-5 |
| | 14 | ESPARRAG O A DEL CILINDRO | 28-12342 |
| | 15 | ESPARRAG O B DEL CILINDRO | 28-12343 |
| | 16 | RODAMIEN TO DE AGUJA HK212810 | 28-GB/T290 |
| | 17 | RETEN DE ACEITE 14 X 28 X 7 | 28-24190 |
| | 18 | O-RING 35,5 X 3 | 28-15462 |
| | 19 | O-RING 13 X 2,5 | 28-11234 |
| | 20 | TORNILLO M6 X 55 | 28-GB/T166 74-6 |
| | 21 | TORNILLO DESAGOTE ACEITE CARTER | 28-11212 |
| | 22 | TORNILLO M6 X 50 | 28-GB/T166 74-7 |
| | 23 | ARANDELA TAPON DE ACEITE CARTER | 28-11213 |
| | 24 | BUJE GUIA 10 X 14 | 28-11118 |
| | 25 | TORNILLO M6 X 25 | 28-GB/T166 74-8 |
| | 26 | CONJUNTO CLAVIJA SUJETA PALANCA | 28-11230 |

